



Modulating control valves with magnetic actuator, PN 16

MVF461H..

for hot water, high temperature hot water and steam

- Short positioning time (<2 s), high resolution (1 : 1000)
- Selectable valve characteristic: Equal-percentage or linear
- High rangeability
- Selectable standard interface DC 0/2...10 V or DC 0/4...20 mA
- Phase-cut signal input for Staefa controllers
- Position control and position feedback signal
- Wear-free inductive stroke measurement
- Spring return facility: A → AB closed when deenergized
- Low friction, robust and maintenance-free

Use

The MVF461H.. valve types are through-port control valves with fitted magnetic actuator. The actuator is equipped with connecting electronics for positioning control and position feedback. When deenergized, the valve is closed.

The short positioning time, high resolution and high rangeability make these valves ideal for proportional control of district heating stations and heating plant using HTHW and steam. For closed circuits only.

Type summary

Type reference	DN	k _{vs} [m ³ /h]	Δp _{max} [kPa]	Δp _s [kPa]	Operating voltage	Positioning		Spring return
						signal	time	
MVF461H15-0.6	15	0.6	1000	1000	AC / DC 24 V	DC 0...10 V or DC 2...10 V or DC 0...20 mA or DC 4...20 mA	< 2 s	✓
MVF461H15-1.5		1.5						
MVF461H15-3		3						
MVF461H20-5	20	5						
MVF461H25-8	25	8						
MVF461H32-12	32	12						
MVF461H40-20	40	20						
MVF461H50-30	50	30						

Δp_{max} = max. permissible differential pressure across the valve's control path, valid for the entire actuating range of the motorized valve

Δp_s = max. permissible differential pressure (close off pressure) at which the motorized valve will close securely against the pressure (used as through-port valve)

k_{vs} = nominal flow rate of cold water (5 to 30 °C) through the fully opened valve (H₁₀₀) at a differential pressure of 100 kPa (1 bar)

Ordering

When ordering, please give quantity, product name and type reference.

Type reference	Stock number	Description
MVF461H15-0.6	MVF461H15-0.6	Flanged valve with magnetic actuator

Valve body and magnetic actuator form one assembly and cannot be separated.

Replacement electronics module

ASE12

Should the valve electronics prove faulty, the electronics module must be replaced by the ASE12 replacement electronics module.

Mounting Instructions 74 319 0404 0 are included.

Rev. no.

Overview table, see page 14.

Technical and mechanical design

For a detailed description of operation, refer to Data Sheet CA1N4028E.

Control operation

The electronics module converts the positioning signal to a phase-cut power signal which generates a magnetic field in the coil. This causes the armature to change its position in accordance with the interacting forces (magnetic field, counterspring, hydraulics, etc.). The armature responds rapidly to any change in signal, transferring the corresponding movement directly to the valve plug, enabling fast changes in load to be corrected quickly and accurately.

The valve's position is measured continuously. Any disturbance in the system is rapidly corrected by the internal positioning controller, which ensures that the positioning signal and the valve stroke are exactly proportional, and also delivers the position feedback signal.

Control

The magnetic actuator can be driven by a Siemens controller or a controller of other manufacture that deliver a DC 0/2...10 V or DC 0/4...20 mA output signal.

To achieve optimum control performance, it is recommended to use a 4-wire connection for the valve. **In case of DC power supply, a 4-wire connection is mandatory!**

The controller's signal ground terminal M must be connected to the valve's terminal M. Terminals M and GO have the same potential and are internally interconnected in the valve's electronics.

Spring return facility

If the positioning signal is interrupted, or in the event of a power failure, the valve's return spring will automatically close control path A → AB.

Manual control

By pressing (a) and turning (b) the hand wheel

- in clockwise (CW) direction, control path A → AB can be mechanically opened to between 80 and 90 %
- in counterclockwise (CCW) direction, the actuator will be switched off and the valve closed

As soon as the hand wheel is pressed and turned, neither the forced control signal Z nor the input signal Y or the phase-cut signal acts on the actuator. The green LED will flash.

For automatic control, the hand wheel must be set to the Auto position. The green LED will be lit.

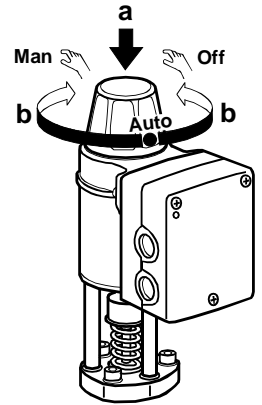

Operator controls and indicators in the electronics housing

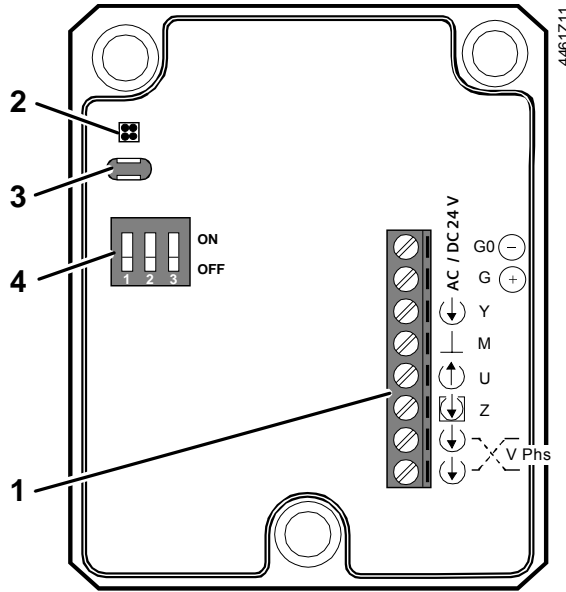

- 1 Connection terminals
- 2 LED for indication of operating state

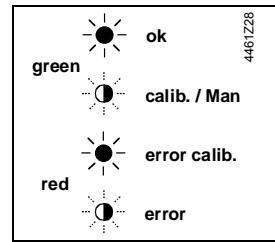

- 3 Slot for autocalibration
- 4 DIL switch for mode control

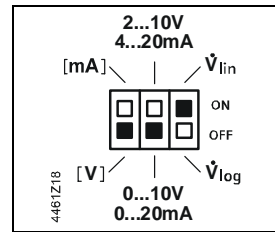

Configuration DIL switches

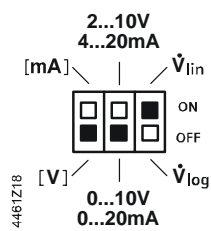

Switch	Function	ON / OFF	Description
1 4461Z19	Positioning signal Y	ON	[mA]
		OFF	[V] ¹⁾
2 4461Z20	Positioning range Y and U	ON	2...10 V, 4...20 mA
		OFF	0...10 V, 0...20 mA ¹⁾
3 4461Z21	Valve characteristic	ON	\dot{V}_{lin} (linear) ¹⁾
		OFF	\dot{V}_{log} (equal-percentage)

¹⁾ Factory settings





Selection positioning signal and range Y

Voltage and current

↓ Y	ON OFF	ON OFF
ON OFF	0...10 V	2...10 V
ON OFF	0...20 mA	4...20 mA

Selection positioning range Y and U:

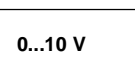
0...10 V / 0...20 mA or
2...10 V / 4...20 mA

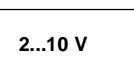
 U	 ON  OFF	 ON  OFF
	Ri > 500 Ω	0...10 V
Ri < 500 Ω	0...20 mA	4...20 mA

Output signal U (position feedback signal) is dependent on the load resistance Ri.

Ri > 500 Ω, → voltage signal



Ri < 500 Ω, → current signal

Selection valve characteristics

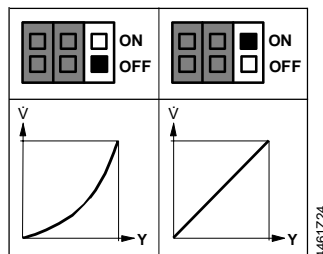
Equal-percentage or linear

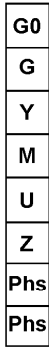

Forced control input Z

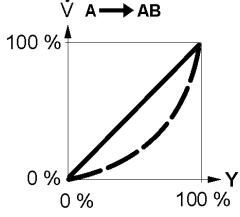
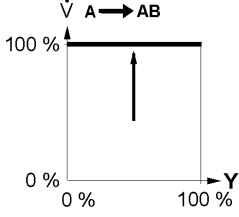
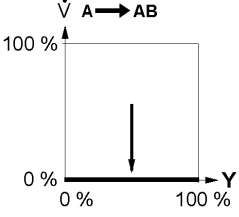
		Z - function		
		no function	fully open	closed
Connections				
	Transfer			
Function		<ul style="list-style-type: none"> Z is not connected The valve will follow the Y-signal or phase-cut signal 	<ul style="list-style-type: none"> Z connected to G The valve will fully open via control path A → AB 	<ul style="list-style-type: none"> Z connected to G0 The valve will close via control path A → AB

Signal priority

1. Hand wheel position Man (open) or Off
2. Forced control signal Z
3. Phase-cut signal Phs
4. Signal input Y

Calibration

If the electronics module is replaced or the actuator turned through 180°, the valve's electronics must be recalibrated. For that, the hand wheel must be set to Auto.



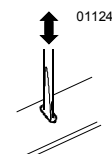

The printed circuit board has a slot (position 3, preceding page).

Calibration is made by bridging the contacts located behind the slot using a screwdriver. The valve will then travel across the full stroke to store the end positions.



While calibration is in progress, the green LED will flash for about 10 seconds (also refer to «Indication of operating state»).

Indication of operating state

LED	Indication	Function	Remarks, troubleshooting
Green	Lit 	Control mode	Normal operation; everything o.k.
	Flashing 	Calibration In manual control	Wait until calibration is finished (green or red LED will be lit) Hand wheel in Man or Off position
Red	Lit 	Calibration error Internal error	Recalibrate (bridge contacts behind the calibration slot) Replace electronics module
	Flashing 	Mains fault DC Supply - / +	Check mains network (outside the frequency or voltage range) DC supply + / - connection rectify
Both	Dark 	No power supply Electronics faulty	Check mains network, check wiring Replace electronics module

Dimension

Working pressure and medium temperature
Fluids

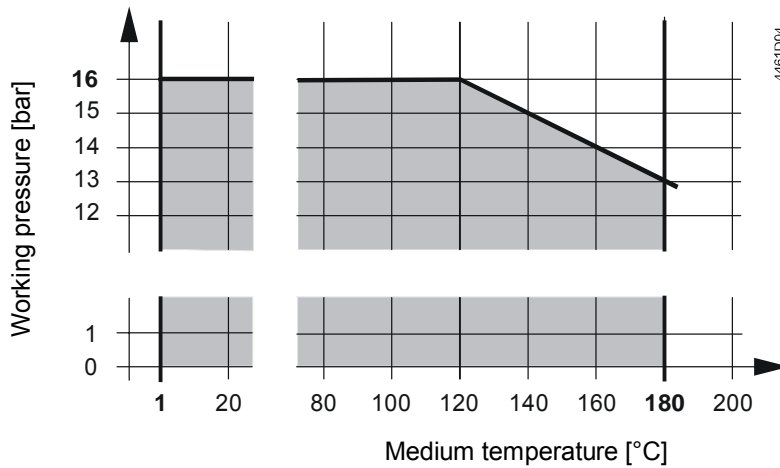

Current local legislation must be observed.

Saturated steam
Superheated steam

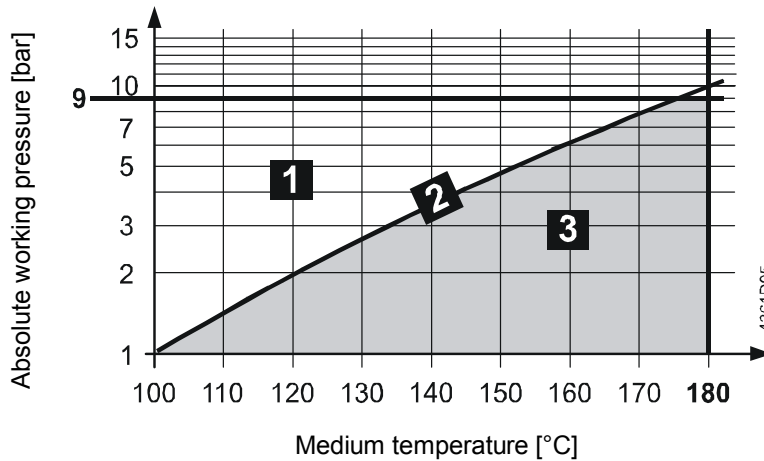

1	Water	-
2	wet steam	avoid
3	saturated steam	permissible range of use
	superheated steam	

Saturated steam flow chart

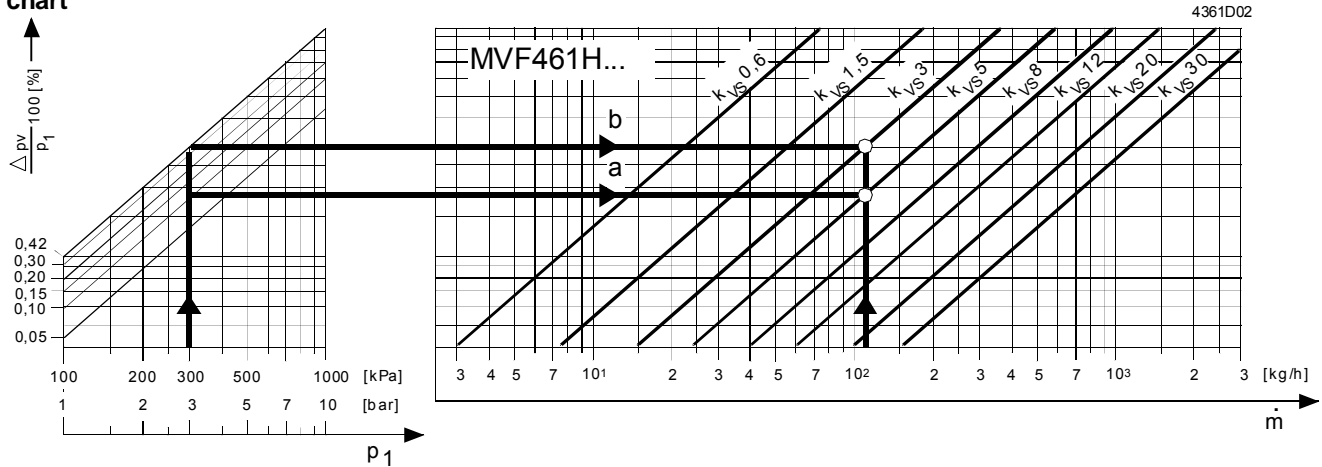

Recommendation

For saturated steam and superheated steam the differential pressure Δp_{max} across the valve should be close to the critical pressure ratio.

$$\text{Pressure ratio} = \frac{p_1 - p_3}{p_1} \cdot 100\%$$

p_1 = absolute pressure before valve in kPa
 p_3 = absolute pressure after valve in kPa

Calculation of the k_{VS} value for steam

Subcritical range

$$\frac{p_1 - p_3}{p_1} \cdot 100\% < 42\%$$

Pressure ratio < 42% subcritical

$$k_{VS} = 4.2 \cdot \frac{\dot{m}}{\sqrt{p_3 \cdot (p_1 - p_3)}} \cdot k$$

Supercritical range

$$\frac{p_1 - p_3}{p_1} \cdot 100\% \geq 42\%$$

Pressure ratio \geq 42% supercritical (not recommended)

$$k_{VS} = 8.4 \cdot \frac{\dot{m}}{p_1} \cdot k$$

\dot{m} = steam quantity in kg/h
 k = factor for superheating of steam = $1 + 0.0013 \cdot \Delta T$ ($k = 1$ for saturated steam)
 ΔT = temperature differential in K between saturated steam and superheated steam

Example

given saturated steam 133.54 °C
 p_1 = 300 kPa (3 bar)
 \dot{m} = 110 kg/h
 pressure ratio = 12 %

required k_{VS} , valve type

procedure

$$p_3 = p_1 - \frac{12 \cdot p_1}{100}$$

$$p_3 = 300 - \frac{12 \cdot 300}{100} = 264 \text{ kPa (2.64 bar)}$$

$$k_{VS} = 4.2 \cdot \frac{110}{\sqrt{264 \cdot (300 - 264)}} \cdot 1 = 4.74 \text{ m}^3/\text{h}$$

selected $k_{VS} = 5 \text{ m}^3/\text{h} \Rightarrow$ MVF461H20-5

saturated steam 133.54 °C
 p_1 = 300 kPa (3 bar)
 \dot{m} = 110 kg/h
 pressure ratio \geq 42 %
 (supercritical permitted)

k_{VS} , valve type

$$k_{VS} = 8.4 \cdot \frac{110}{300} \cdot 1 = 3.08 \text{ m}^3/\text{h}$$

$k_{VS} = 3 \text{ m}^3/\text{h} \Rightarrow$ MVF461H15-3

Water flow chart

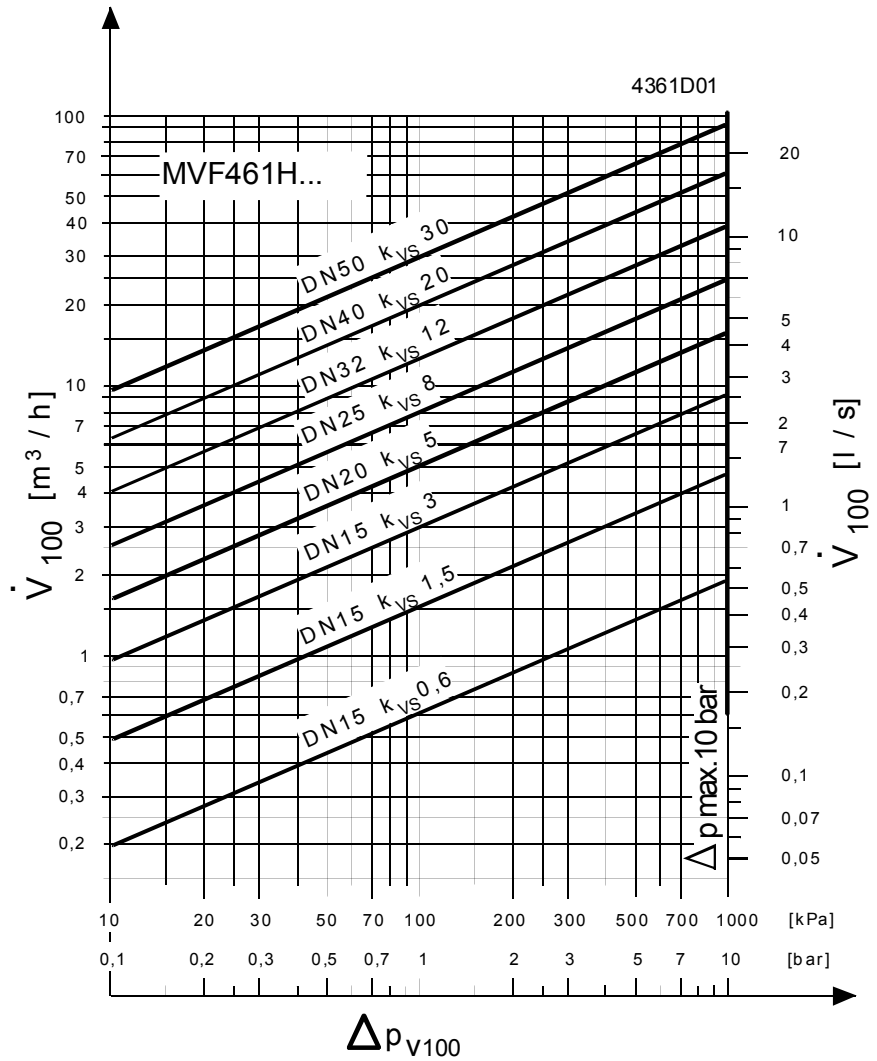

- Δp_{V100} = differential pressure across the fully open valve and the valve's control path A → AB by a volume flow \dot{V}_{100}
- \dot{V}_{100} = volume flow through the fully open valve (H_{100})
- Δp_{max} = max. permissible differential pressure across the valve's control path for the entire actuating range of the motorized valve
- 100 kPa = 1 bar \approx 10 mWC
- 1 m³/h = 0,278 l/s water at 20 °C

Valve characteristic

Equal-percentage

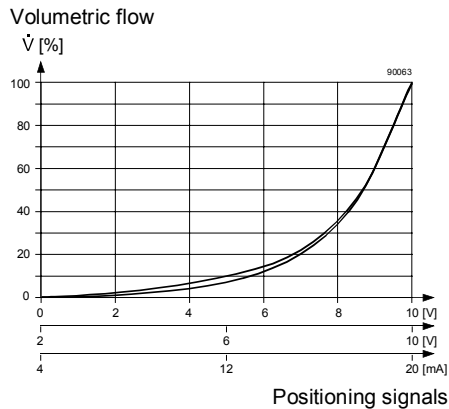

Linear

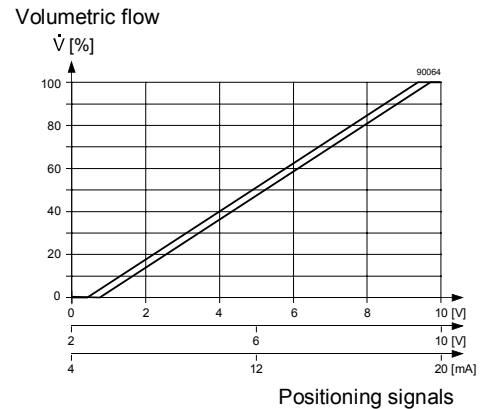

Connection type ¹⁾

The 4-wire connection should always be given preference!

4-wire connection

Type reference	S_{NA} [VA]	P_{MED} [W]	S_{TR} [VA]	P_{TR} [W]	I_F [A]	Wire cross-section [mm ²]		
						1,5	2,5	4,0
MVF461H15-0.6	33	15	≥50	≥50	3.15	60	100	160
MVF461H15-1.5								
MVF461H15-3								
MVF461H20-5								
MVF461H25-8								
MVF461H32-12	43	20	≥75	≥70	4	40	70	120
MVF461H40-20	65	26	≥100		6.3	30	50	80
MVF461H50-30								

S_{NA} = nominal apparent power

P_{med} = typical power consumption in the application

S_{TR} = Minimum apparent transformer power

P_{TR} = Minimum DC supply power

I_F = Minimal required slow fuse

L = max. cable length; with 4-wire connections, the max. permissible length of the separate 1.5 mm² copper positioning signal wire is 200 m

¹⁾ All information at AC 24 V or DC 24V

Mounting notes

The valve is supplied complete with Mounting Instructions 74 319 0378 0.

Caution 

**The valve may only be used in flow direction (A → AB).
Observe the direction of flow!**

Mounting position

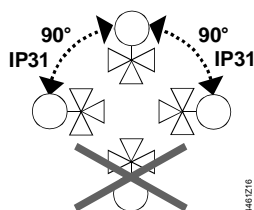

Installation notes

- The actuator may not be lagged
- For electrical installation, refer to «Connection diagrams».

Maintenance notes

The low friction and robust, maintenance-free design makes regular servicing unnecessary and ensure a long service life.
The valve stem is sealed from external influences by a maintenance-free gland.
If the red LED is lit, the electronics must be recalibrated or replaced.

Repair

Should the valve electronics prove faulty, the ASE12 electronics module must be replaced (refer to Mounting Instructions 74 319 0404 0).

Caution 

Always disconnect power before fitting or removing the electronics module.

After replacing the electronics module, calibration must be triggered in order to optimally match the electronics to the valve (refer to «Calibration»).

Disposal

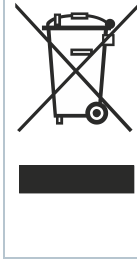

The device is considered electrical and electronic equipment for disposal in terms of the applicable European Directive and may not be disposed of as domestic garbage.

- Dispose of the device through channels provided for this purpose.
- Comply with all local and currently applicable laws and regulations.

Warranty

Application-specific technical data must be observed.

If specified limits are not observed, Siemens will not assume any responsibility.

Technical data

Functional data of actuator

Power supply

For use with low-voltage only (SELV, PELV)

AC 24 V	Operating voltage	AC 24 V $\pm 20\%$ (SELV) or AC 24 V class 2 (US)
	Frequency	45...65 Hz
	Typical power consumption P_{med}	refer to «Connection type», page 8
	Standby	< 1 W (valve fully closed)
	Rated apparent power S_{NA}	refer to «Connection type», page 8
	Required fuse I_F	slow, «Connection type», page 8
	External supply line protection	Fuse slow max. 10 A or Circuit breaker max. 13 A Characteristic B, C, D according to EN 60898 or Power source with current limitation of max. 10 A
DC 24 V	Operating voltage	DC 20...30 V
Signal inputs	Control signal Y	DC 0/2...10 V or DC 0/4...20 mA
	or phase cut signal	DC 0...20 V Phs
	Impedance DC 0/2...10 V	100 k Ω // 5nF (load < 0.1 mA)
	DC 0/4...20 mA	240 Ω // 5nF
Signal outputs	Forced control Z	
	Impedance	22 k Ω
	Closing the valve (Z connected to G0)	< AC 1 V; < DC 0.8 V
	Opening the valve (Z connected to G)	> AC 6 V; > DC 5 V
	No function (Z not wired up)	phase-cut or control signal Y active
	Position feedback signal voltage	DC 0/2...10 V; load resistance > 500 Ω
	current	DC 0/4...20 mA; load resistance \leq 500 Ω
	Stroke measurement	inductive
	Nonlinearity	$\pm 3\%$ of end value
Positioning time	Positioning time	< 2 s
Electrical connections	Cable entries	2 x \varnothing 20,5 mm (for M20)
	Connection terminals	screw terminals for 4 mm ² wires
	Min. wire cross-section	0.75 mm ²
	Max. cable length	refer to «Connection type», page 8

Functional data of valve

Pressure class		PN16 to EN 1333
Permissible operating pressure ¹⁾		within the permissible "medium temperature" range according to the diagram on page 5 Water up to 120 °C: 1.6 MPa (16 bar) Water above 120 °C: 1.3 MPa (13 bar) Saturated steam: 0.9 MPa (9 bar)
Differential pressure $\Delta p_{\max} / \Delta p_s$		1 MPa (10 bar)
Leakage rate at $\Delta p = 0.1$ MPa (1 bar)		A → AB max. 0.05 % k_{VS}
Valve characteristic ²⁾		equal percentage, $n_{gl} = 3$ to VDI / VDE 2173 or linear, optimized near the closing point
Permissible media	Water	chilled water, low temperature hot water, high temperature hot water, water with anti-freeze; recommendation: water treatment to VDE 2035
	Steam	Saturated steam, superheated steam dryness at inlet minimum 0.98
Medium temperature		>1...180 °C
Stroke resolution $\Delta H / H_{100}$		1 : 1000 (H = stroke)
Position when actuator is deenergized		A → AB closed
Mounting position		upright to horizontal
Control mode		modulating
Materials	Valve body	modular cast iron EN-GJS-400-18-LT
	Covering flange	modular cast iron EN-GJS-400-18-LT
	Seat / plug	CrNi-steel
	Valve stem seal	EPDM (O-ring)
Weight and dimensions	Dimensions	refer to «Dimensions»
	Weight	refer to «Dimensions»
Norms and directives	Electromagnetic compatibility (Application)	For residential, commercial and light-industrial environments
	Product standard	EN60730-x
	EU Conformity (CE)	CA2T4361.1 ³⁾
	RCM Conformity	A5W00004454 ³⁾
	EAC Conformity	Eurasia Conformity for all MVF..
	Housing protection	
	Upright to horizontal	IP31 to EN 60529
	Vibration ⁴⁾	EN 60068-2-6 (1 g acceleration, 1...100 Hz, 10 min)
	UL certification (US)	UL 873, http://ul.com/database
	CSA certification	C22.2 No. 24, http://csagroup.org
	Environmental compatibility	The product environmental declaration CE1E4361en ³⁾ contains data on environmentally compatible product design and assessments (RoHS compliance, materials composition, packaging, environmental benefit, disposal).
	Pressure Equipment Directive	PED 2014/68/EU
	Pressure accessories	Scope: Article 1, section 1 Definitions: Article 2, section 5
	Fluid group 2: DN 15...50	without CE-marking as per article 4, section 3 (sound engineering practice) ⁵⁾

¹⁾ Tested at 1.5 x PN (24 bar), similar to EN 12266-1

²⁾ Can be selected via DIL switch

³⁾ The documents can be downloaded from <http://siemens.com/bt/download>.

⁴⁾ In case of strong vibrations, use high-flex stranded wires for safety reasons.

⁵⁾ Valves where PS x DN < 1000, do not require special testing and cannot carry the CE label.

General environmental conditions

	Operation EN 60721-3-3	Transport EN 60721-3-2	Storage EN 60721-3-1
Climatic conditions	Class 3K5	Class 2K3	Class 1K3
Temperature	-5...+45 °C	-25...+70 °C	-5...+45 °C
Humidity	5...95 % r.h.	5...95 % r.h.	5...95 % r.h.
Mechanical conditions	EN 60721-3-6 Class 3M2		

Connection terminals

4461A06	G0	⊖	System neutral AC 24 V, DC 20...30 V
	G	⊕	System potential AC 24 V, DC 20...30 V
	Y	↓	Control signal DC 0/2...10 V, DC 0/4...20 mA
	M	⊥	Measuring neutral (= G0)
	U	↑	Position feedback signal DC 0/2...10 V, DC 0/4...20 mA
	Z	↕	Forced- control input Z
	Ph	↔	Phase-cut signal DC 0...20 V Phs, interchangeable, galvanically isolated
	Ph	↔	Phase-cut signal DC 0...20 V Phs, interchangeable, galvanically isolated

Connection diagrams

Warning ⚠

If controller and valve receive their power from separate sources, only one transformer may be earthed on the secondary side.

Caution ⚠

In case of DC power supply, a 4-wire connection is mandatory!

Terminal assignment for controller with 4-wire connection (to be preferred!).

- DC 0...10 V
- DC 2...10 V
- DC 0...20 mA
- DC 4...20 mA

Common Transformer

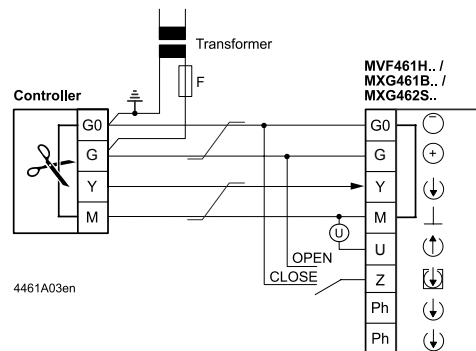

Separate Transformer

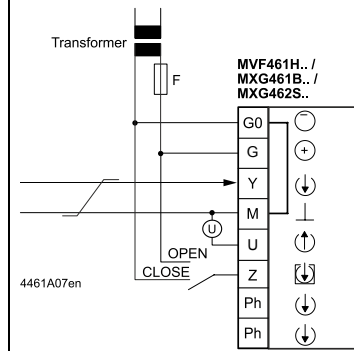

Terminal assignment for controller with 3-wire connection

- DC 0...10 V
- DC 2...10 V
- DC 0...20 mA
- DC 4...20 mA

Common Transformer

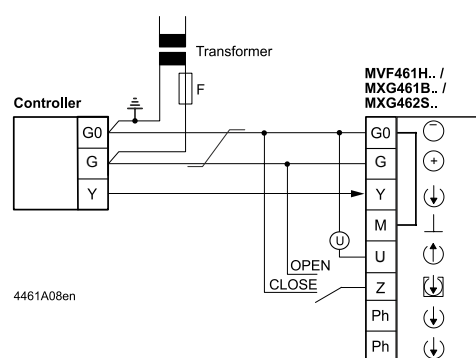

Separate Transformer

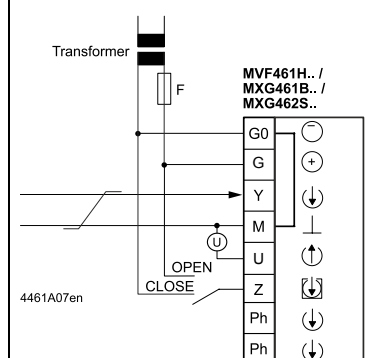

⊕ Indication of valve position (only if required). DC 0 ...10 V → 0...100 % volumetric flow V_{100}

↔ Twisted pairs. If the lines for AC 24 V power supply and the DC 0...10 V (DC 2...10 V, DC 4...20 mA) positioning signal are routed separately, the AC 24 V line need not be twisted.

Warning ⚠

Piping must be connected to potential earth!

Controllers with phase-cut DC 0...20 V Phs

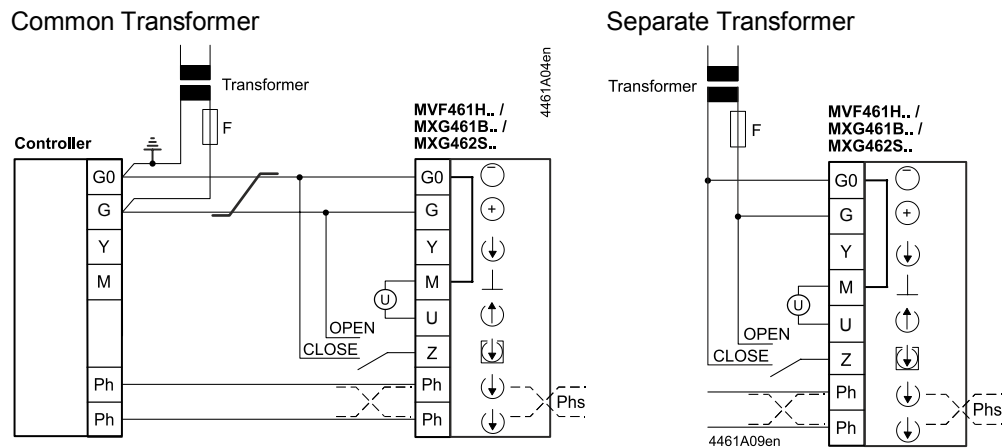

Application examples

The examples shown below are basic diagrams with no installation-specific details.

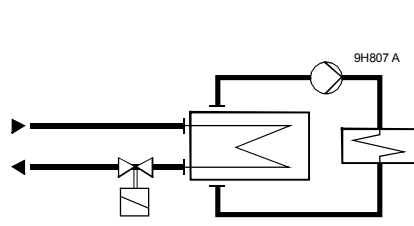

District heating (supply heating) system, indirect connection.

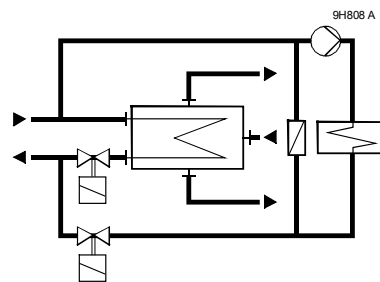

District heating (supply heating) system, directly connected to water-heating system

Caution

The valve may only be used in flow direction (A → AB). The direction of flow must be observed!

Dimensions

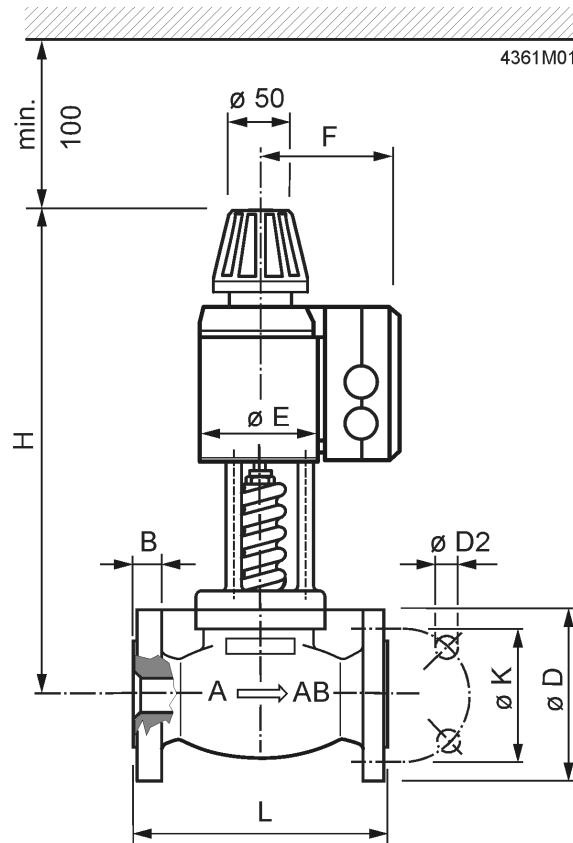

Flange dimensions to DIN2533, PN16

Type reference	DN	L [mm]	ø D [mm]	ø D2 [mm]	B [mm]	ø K [mm]	H [mm]	ø E [mm]	F [mm]	Weight [kg]
MVF461H15-0.6	15	130	95	4x14	14	65	340	80	115	8,3
MVF461H15-1.5	15	130	95	4x14	14	65	340	80	115	8,3
MVF461H15-3	15	130	95	4x14	14	65	340	80	115	8,3
MVF461H20-5	20	150	105	4x14	16	75	339	80	115	8,9
MVF461H25-8	25	160	115	4x14	16	85	346	80	115	10,0
MVF461H32-12	32	180	140	4x18	18	100	384	100	125	15,7
MVF461H40-20	40	200	150	4x18	18	110	401	100	125	17,8
MVF461H50-30	50	230	165	4x18	20	125	449	125	138	27,2

Weight incl. packaging

Revision numbers

Type reference	Valid from rev. No.
MVF461H15-0.6	..C
MVF461H15-1.5	..C
MVF461H15-3	..C
MVF461H20-5	..B
MVF461H25-8	..B
MVF461H32-12	..B
MVF461H40-20	..C
MVF461H50-30	..B

Issued by
Siemens Switzerland Ltd
Building Technologies Division
International Headquarters
Gubelstrasse 22
6301 Zug
Switzerland
Tel. +41 58-724 24 24
www.siemens.com/buildingtechnologies

© Siemens Switzerland Ltd, 2010
Technical specifications and availability subject to change without notice.